

Commercial Ice Maker User Manual for Installation and Maintenance



Table of Contents

Important Information	1
Warning and safety instruction.....	2
General.....	3
Installation.....	3
Location for Installation.....	3
Schematic Diagram of Installation.....	4
Installation Steps.....	4
Startup and Operation.....	2
Operation Instruction.....	2
Instruction of Control Panel.....	6
Maintenance	6
Clean Function	8
Common Faults and Troubleshooting.....	9
Warranty.....	10

 Note: please keep this manual in a place accessible to users at any time.

Important Information

Please pay attention to the following warning labels on the ice maker

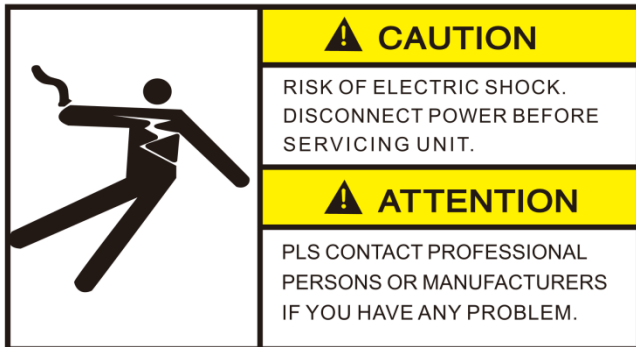

The label indicates a hazardous voltage. There is a risk of electric shock.

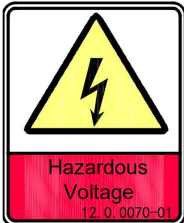

The label indicates a hazardous voltage. There is a risk of electric shock.

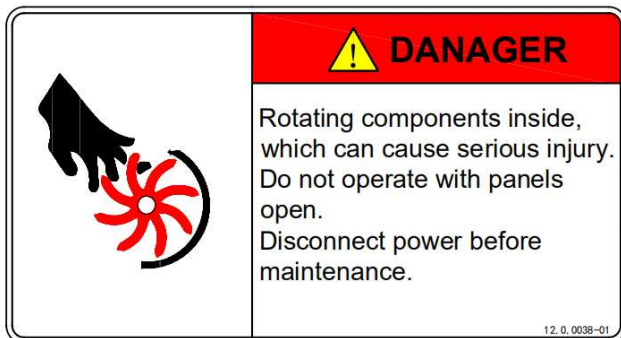

The label indicates rotating components inside. There is a risk of serious mechanical injury.

Instruction of symbols in this Manual

 Alert sign: indicating the item requiring particular attention.

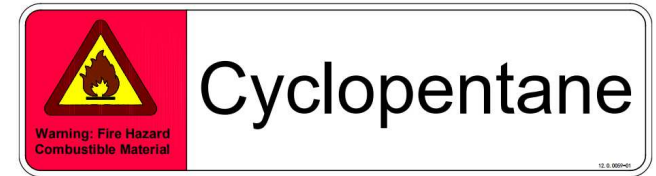



The label indicates a flammable foaming agent “Cyclopentane” used. There is a risk of fire.



R290

The label indicates a flammable refrigerant “R290” used. There is a risk of fire.

 **Warning:** The ice making water inlet of ice maker can only be connected with drinking water, and groundwater or other non drinking water sources can not be used.

 Warning sign: special attention is required and operation is prohibited.

Warning and safety instruction

⊘ This product cannot be used in outdoor environment.

⚠ This ice machine is not intended for use by children, and those with physical weakness, slow response, or mental disorders.

- ✦ The installation, repair or maintenance of this ice machine must be carried out by professional and qualified personnel, or electric shock, fire, personal injury may cause from incorrect operation.
- ✦ After the ice machine is delivered, please keep the machine still upright for more than 24 hours, to have the lubricant be fully precipitated before startup, otherwise the compressor may be damaged.
- ✦ **When the power cord of the ice maker is damaged, in order to avoid electric shock, fire or personal injury, it must be replaced by the manufacturer or professional and qualified personnel.**
- ✦ **The water pipe assembly in the accessory box of the ice maker must be used. In order to ensure food safety, the water pipe assembly removed from the old machine should not be used.**
- ✦ When handling, keep the cabinet upright, with the inclination not exceeding 45 degrees. **Do not** invert the machine or lay it horizontally.
- ✦ This ice machine should not be placed in wet or easily splashed area.
- ✦ The grounding of this ice machine cannot be connected to gas pipe, water pipe, telephone line or lightning rods, etc.
- ✦ There are rotating components in this ice machine. Do not insert slim objects into ventilation or exhaust ports, or serious mechanical injury may occur.
- ✦ Do not store volatile or flammable substances in this ice machine, or it may result in explosion or fire.
- ✦ Do not store any **sundries**, or freeze any food in the storage bin. Keep the ice scoop clean.
- ✦ The ice machine must be placed on the floor sufficient to supports its weight. Insufficient base may cause the equipment fall over and cause injury.
- ✦ There should be sufficient ventilation space around the ice machine. Keep good ventilation.
- ✦ Only the power supply specified on the machine nameplate can be used with this ice machine.
- ✦ This ice machine cannot be connected to hot water.
- ✦ Socket for this ice maker must be reliably grounded and with leakage protection.
- ✦ The ice machine must be disconnected from power before **manual** cleaning, repairing and maintenance.
- ✦ Before cleaning, repairing and maintenance, the remaining ice in the ice bin should be removed from the ice **machine** to avoid contamination to ice.
- ✦ Do not splash water directly onto the surface of the ice machine during the cleaning process; otherwise it may cause short circuit, leakage or other faults.
- ✦ Flammable foaming agent is used during the foaming process. The ice maker should be disposed of and recycled by qualified personnel and institutions.
- ✦ The ice machine should be properly managed to ensure that children will not play with the machine.
- ✦ When the ice machine malfunctions, turn off the power and contact professional personnel for repairing



R290

For the ice maker with flammable refrigerant R290:

- DANGER – RISK OF FIRE OR EXPLOSION. FLAMMABLE REFRIGERANT USED. MUST BE ENOUGH VENTILATION SPACE AROUND THE ICE MAKER TO KEEP THE VENTILATION SMOOTH.
- DANGER – RISK OF FIRE OR EXPLOSION. FLAMMABLE REFRIGERANT USED. DO NOT USE MECHANICAL DEVICES TO DEFROST REFRIGERATOR. DO NOT PUNCTURE REFRIGERANT TUBING.
- DANGER – RISK OF FIRE OR EXPLOSION. FLAMMABLE REFRIGERANT USED. TO BE REPAIRED ONLY BY TRAINED SERVICE PERSONNEL. DO NOT PUNCTURE REFRIGERANT TUBING.
- DANGER – RISK OF FIRE OR EXPLOSION. FLAMMABLE REFRIGERANT USED. DO NOT USE ANY ELECTRICAL APPLIANCES IN THE ICE STORAGE BIN OF THE ICE MAKER.
- CAUTION – RISK OF FIRE OR EXPLOSION. FLAMMABLE REFRIGERANT USED. CONSULT REPAIR MANUAL/OWNER'S GUIDE BEFORE ATTEMPTING TO SERVICE THIS PRODUCT. ALL SAFETY PRECAUTIONS MUST BE FOLLOWED.
- CAUTION – RISK OF FIRE OR EXPLOSION. DISPOSE OF PROPERLY IN ACCORDANCE WITH FEDERAL OR LOCAL REGULATIONS. FLAMMABLE REFRIGERANT USED.
- CAUTION – RISK OF FIRE OR EXPLOSION DUE TO PUNCTURE OF REFRIGERANT TUBING; FOLLOW HANDLING INSTRUCTIONS CAREFULLY. FLAMMABLE REFRIGERANT USED.

General

The ice machine is fully automatic. With proper installation and connection to potable water and power source, the ice making will start properly. When the ice cubes fill up the storage bin, the machine will automatically stop. The ice machine is generally used in the following and similar occasions:

- The kitchen area of a store, office or other workplace;
- Farm, hotel, car hotel and restaurant;
- Catering and similar non-retail occasions;
- This ice machine is not intended for used at home.

Installation

Location for Installation

The ice machine should be installed in a proper location meeting the following conditions:

- Indoor, not more than 2,000 meters above sea level;
- Ambient temperature: 5-40°C;
- Power supply: the rated voltage indicated on the machine nameplate $\pm 6\%$;
- Water source: potable water, with water pressure from 0.13MPa to 0.55MPa; water temperature: 5-35°C;
- The ice machine should be kept away from heat sources, and should be strictly forbidden to use at extremely high temperature or low temperature environment, and should avoid direct sunlight.
- There should be sufficient ventilation space around the ice machine and keep good ventilation; the distance from the ice maker to the wall should be no less than 30 cm for the front, 15cm for the sides, and 20 cm for the rear.
- The ice machine must be placed on a floor sufficient to support its weight;
- Socket for the ice maker must be reliably grounded and with leakage protection;
- Proper floor drainage must be provided near the installation location of the ice machine.

Schematic Diagram of Installation

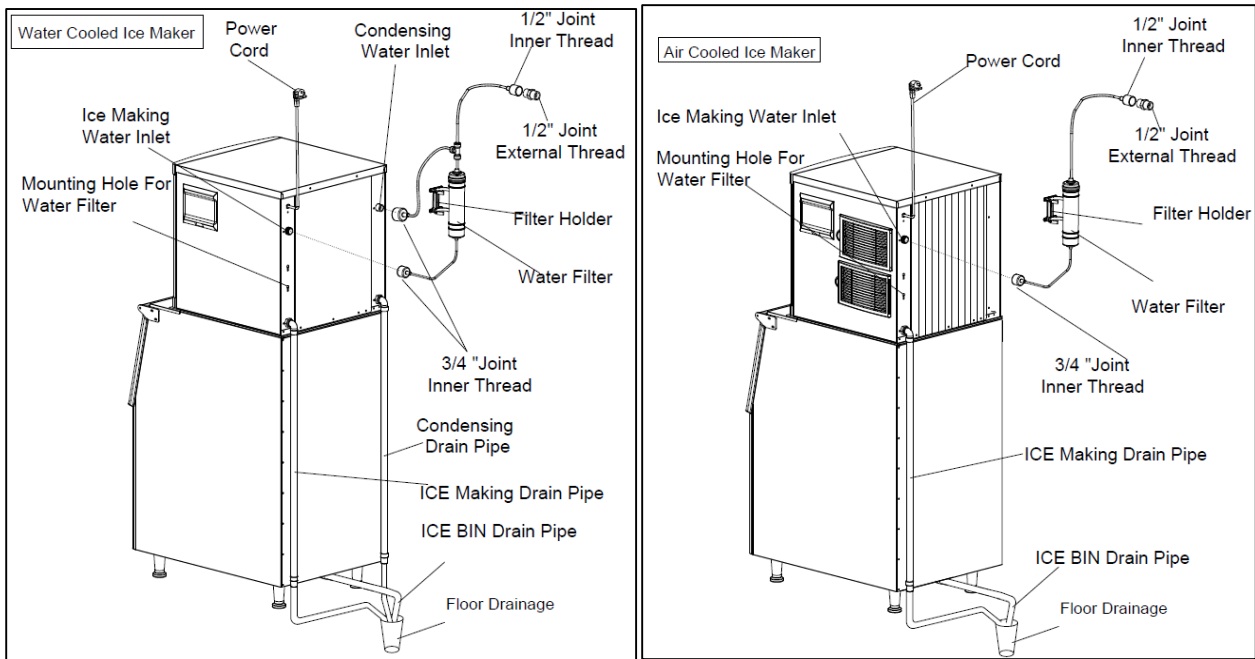

Installation Steps

1. Check if the ice machine is in good condition and the accessories are complete; check the machine model and the machine nameplate.
2. Clean the ice storage bin and the food area inside with a sponge soaked in warm water and soda. Then wash and dry it with potable water.
3. Place the ice machine in the operation area; ensure that the machine is placed on a leveled floor. So as to ensure the water flows evenly on the evaporator.
4. The compressor chamber is located at the back. The compressor and condenser are installed in it. For air cooled unit, it requires good ventilation. Therefore, the front and rear of the ice maker must have ventilation space of more than 20-30 cm.
5. The bottom of the ice machine is equipped with adjustable legs for level adjustment and floor cleaning.
6. Connect the machine's inlet water filter and water pipe referring to the schematic diagram of installation; if the installation site is already equipped with a drinking water system, the water filter may not be installed.

⚠ Note: the filter flow direction should be correctly installed as per the direction marker on the filter head cover or the filter body.

⚠ Note: This machine is equipped with an inlet water filter. The filter will have impurities from the water accumulated as the machine is running. Generally, it needs to be replaced every month to every 3 months.

7. Connect the machine to the water supply using the 3/4" inlet pipe supplied with the machine. It is recommended to install a water valve (not supplied with this machine) on the water supply line.
8. Connect the drain pipe to the drain connection. In order to meet a good draining, it is recommended that the drain pipe should have a difference of level more than 3cm per meter; and confirm that the drain pipe is not blocked. It is recommended that the drain pipe be connected to an open drainage port.
9. Any joint in the drain pipe must not be higher than the machine drainage port; any joint in the drain pipe cannot be higher than the previous joint.
10. Confirm the power requirements stated in the machine nameplate; ensure that the power supply meets the requirements.
11. A circuit breaker or switch with leakage protector and reliably grounding is required.
12. Turn off the switch on the power line and connect the machine to the power

source.

Startup and Operation

1. Before you start up the machine, please check and confirm:
 - That the packaging tape inside the ice machine has been removed;
 - The accessories or items in the ice bin have been taken out;
 - The ice machine has been adjusted to a leveled state;
 - The water pipe has been connected and the water valve is open;
 - The plug has been connected to the power supply and the power switch is off.
 - The ambient temperature, water temperature, and pressure of the water supply meet the above requirements.
2. Start up: turn on the power switch. After power-on, the machine begins to make ice automatically.
3. For normal operation, please confirm:
 - ✓ There is water in the water trough and no overflow occurs;
 - ✓ The pump is working properly and water is flowing evenly on the evaporator;
 - ✓ The compressor is running normally, the temperature of the evaporator and the ice making water is gradually decreasing;
 - ✓ **For air cooled machine**, check the fan is running normally, and there is stable air flow in the inlet and outlet of the ice machine;
 - ✓ The ice machine has no abnormal noise;
 - ✓ The ice machine has no abnormal vibration;
 - ✓ It takes about 10 to 20 minutes to make one batch ice, depending on the ambient temperature and the temperature of the water. The higher the temperature is, the longer the ice making will take;
 - ✓ Ice cube can be properly defrosted from the machine.

Operation Instruction

- **Startup:** after proper installation, connect the water source and turn on the power supply, the machine will start working. Please confirm that the machine is operating normally when you turn it on for the first time.

⚠ Note: In case of thunderstorm or not in use for a long time, please disconnect the power and water source!

- **Self-check:** with power on for the first time, the ice maker will do self-check and pump out remaining water.
- **Preparing:** after the ice machine is energized, the inlet valve opens and the inlet water will flow in until it reaches the set level; then the ice maker will do defrosting one time.
- **Ice making:** after pre-cooling for 30 seconds, the water pump starts, the water flows through the evaporator smoothly and evenly, the ice cubes are gradually formed in the ice cube tray.
- **Ice Harvest:** after the ice making process, the water pump is turned off,

the defrosting valve is turned on, and after the hot gas enters into the evaporator for about 1-2 minutes, the ice cubes slides from the evaporator into the storage bin.

⊘ Warning: Do not put your hand into the ice storage bin during the ice-falling process to prevent the ice from hitting your hand!

- **Shutdown:** The ice maker will stop working when you click the “on/off” button on the panel during running process.
- **Bin full stop:** in the running state, with the storage bin filled to a certain height, the ice sliding board cannot be rebounded or reset because of the block of the freshly produced ice cubes, the ice maker will stop in 40 seconds.
- **Repeat ice-making:** when the ice cubes on the ice sliding board are taken away, the ice maker will back to ice making process in a few seconds.

Instruction of Control Panel

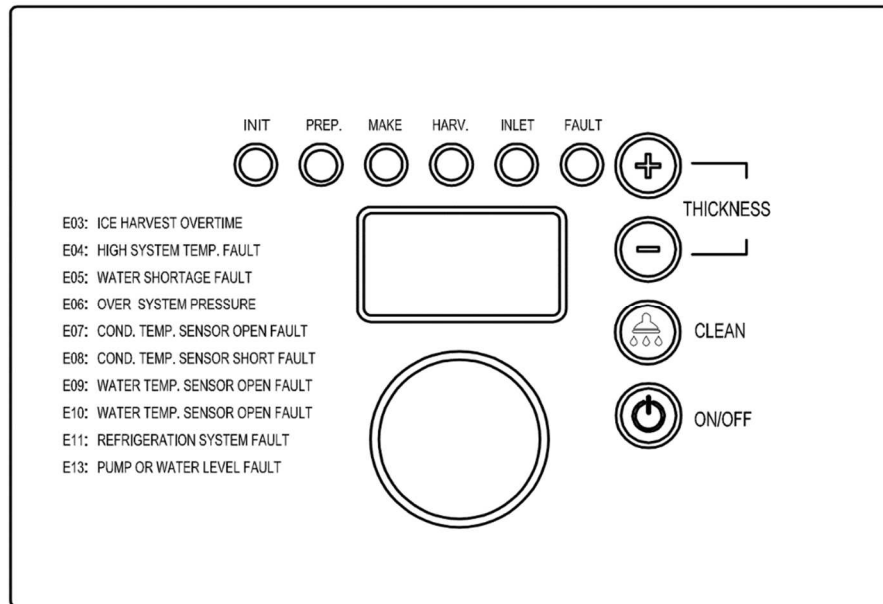

1. LED Display:
 - Self-check : Display “ini” code.
 - Preparing : Counting seconds positively.
 - Ice making: Counting seconds positively prior the water reaching 0 degree C. Counting seconds down to 0 s after.
 - Ice Harvest: Counting seconds positively.
 - Clean: Display “CLE” during cleaning and sterilizing; Display “rin” during rinsing.
 2. LED Lamps: Lights on during the related process.
 3. Ice cube thickness adjustment: During the ice making process, if you are not satisfied with the ice thickness, press the Ice cube “-” button for 3 seconds, then click the button “+” or “-” on the panel to adjust the thickness of ice cube.
- ⚠ Note: By clicking the “+” or “-” button one time, the ice making time is extended or shortened by 1.5 minutes.**
4. Cleaning: During the normal operation, hold the cleaning button for 3 seconds to enter the cleaning process. During the entire cleaning process, cleaning agents and disinfectants need to be put into the water trough. When the clean process is finished, the ice maker will go to ice making process.
 5. Switch: When the device is powered, click the “Switch” button to switch OFF/ON the device.
 6. Voice function (only for machines with voice function): The machine with voice announcement prompts will provide voice prompts for related operations.
 7. Please open and close the storage bin door gently. Do not slam the door. After taken the ice cubes, please close the door.
 8. If the ice maker is not in use for a long time, it should be energized and run for 2 to 4 hours every 2 months.
- Other special protection - shutdown**
- If the ice machine has not detected ice cube falling off in three cycles, it will shut down for safety protection. The ice maker needs to be checked.
 - The ice machine detects that the ambient temperature is too high and will stop for safety protection.
 - If the water-cooled ice machine detects an abnormality in water supply, it will stop for safety protection.

- The fault code and its comments are displayed as follows:

Code	Comments	Machine action
E01	Sliding board fails	Protective shutdown
E03	Overtime of ice making	Protective shutdown
E04	High temperature	Protective shutdown
E05	Water shortage	Protective shutdown
E06	High pressure	Protective

		shutdown
E07	Condensation sensor open circuit	Not stop
E08	Condensation sensor short circuit	Not stop
E09	Water temp. sensor open circuit	Not stop
E10	Water temp. sensor short circuit	Not stop

Maintenance

⚠️ Note: Maintenance must be done by a qualified professional personal.

🚫 Warning: Before maintenance or manual clean, be sure to cut off the water source and power supply.

Exterior cleaning

- Frequently clean the environment around the ice machine to keep it clean. Do not block the vents.
- The outer enclosure should be cleaned with a mild detergent and then wiped clean. If necessary, use commercial stainless steel cleaners and polishes.

⚠️ Note: Stainless steel may rust without proper maintenance.

Inlet water filter

- The filter element should be inspected regularly. It is recommended to replace filter element every month to every 3 months.

Interior cleaning

- The inside of the ice storage bin can be washed directly with water pipes.

⚠️ Note: Check and confirm the water pressure lower than the maximum allowed pressure. Do not flush the part above the

⚠️ Note: Be careful when doing the condenser cleaning as the edges of the fins are sharp.

Water pipe

- In order to ensure food safety, the water pipe of the ice machine should be cleaned regularly.

water pump or the evaporator directly for water protection.

Condenser

- For the air-cooled ice maker, the condenser should be cleaned every three weeks. Use a soft brush or a vacuum cleaner with a brush to brush it up and down along the fin direction, to avoid damage to the fins and further affecting the cooling effect.
- The condenser filter should be cleaned every 2 weeks.

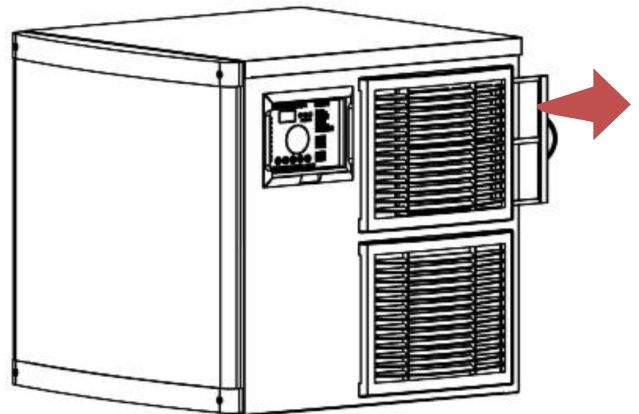

Wintering

- Turn off the water and power supply, drain the residual water from the water trough, inlet pipe and drain pipe.

⚠️ The maintenance of the ice machine is not covered by the manufacturer's warranty!

Clean Function

⚠️Note: Please empty the bin of ice in advance.

⚠️Note: Please clean and sterilizing the bin and do complete rinsing.

⚠️Note: Please clean and sterilizing the ice sliding board, water distribution pipe, water supply pipe, water pump, then do complete rinsing.

- Turn on the ice maker; push “clean” button for 3 seconds, the ice maker will get into clean process. Put in proper amount of clean solution manually followed by the clean and sterilizing process instruction.
- Push “clean” button. The ice maker will do auto clean for about 15 minutes. Please do spray cleaning to the evaporator at the mean time to insure a

complete clean. When finished, the led display flashes “Clean” slowly again.

- Put in proper amount of sterilizing solution manually followed by the clean and sterilizing process instruction. Push the “clean” button again, the ice maker will do auto sterilizing for about 15 minutes. Please do spray sterilizing to the evaporator at the mean time to insure a complete sterilizing. When finished, the ice maker will get into rinsing process, the process will take about 5 minutes , and do 5 cycles rinsing.
- The ice maker will get back to do ice making as soon as the clean process end.
- Please throw away the next 5 batches ice in case of cleaner remained.

Service Call

If the ice machine works abnormally, please confirm below before making a service call:

1. Check the water supply
 - ✓ whether there is water in the water trough;
 - ✓ whether the water pressure for the ice machine is 0.13MPa to 0.55MPa; the water temperature is 5-35 °C;
 - ✓ whether the water valve is open;
 - ✓ whether there is no water leakage;
2. Check the power
 - ✓ whether the indicator on the display panel is ON;
 - ✓ whether the panel display does not display the OFF standby state;

- ✓ If the LED on the display panel is not ON, check whether the plug and socket are normal, and whether the power supply switch is ON.
- 3. Check nameplate and series number
 - ✓ Check the nameplate located on the side or back of the ice machine and record the model and series number of the ice machine.

⚠️Note: If the machine fails due to the user’s faults, such as no supply of water, electricity or environmental factors, rather than the fault of the ice maker, the door-to-door service will be charged.

Common Faults and Troubleshooting

Fault	Potential cause	Troubleshooting
Not working Indicator is OFF	Power switch not turned on Plug is loose	Turn on the power switch Check plug and socket
Shutdown every 3 minutes after startup; the display shows E04 high temperature The display shows E06 high pressure protection	The ambient temperature is too high Condenser is dirty and blocked High pressure switch wires fallen off Fan does not start	Normal working temperature range of 5-40 °C Clean the condenser Check and correct high pressure switch wires Check and correct the fan
Ice defrost abnormal	Ambient temperature too low Defrost valve does not start normally Ice thickness too thin or too thick	Normal working temperature range of 5-40 °C Check and correct the defrosting valve Check and correct ice thickness setting
Poor transparency of ice cubes; ice cubes too thin or incomplete	Ice thickness too thin Water pressure too low Water temperature too high Inlet water valve does not work Inlet water valve is dirty and blocked Water leaking Inlet water filter has not been replaced for a long time	Check and correct ice thickness setting Check that the water supply pressure is 0.13MPa to 0.55MPa Water temperature of 5-35 °C Check and correct the inlet water valve Check whether water leaks and correct Check and correct the inlet water filter
Too slow in ice making	The condenser or air filter is dirty High ambient temperature Poor ventilation Water temperature is too high	Clean the condenser and filter screen Normal working temperature range of 5-40 °C Check the environment around the ice machine Check the water supply temperature of 5-35 °C
Too much noise	The ice machine is not placed in a leveled foundation or the ice maker is not leveled.	Level the ice machine

Warranty

The following circumstances are not covered by the warranty:

- Normal cleaning or maintenance;
- Unauthorized modification of the ice machine or use of non-native parts;
- Damage caused by improper power supply, water supply and drainage;
- Damage caused by installing, cleaning or maintaining of the ice machine not in accordance with the instructions of this manual;
- Artificial damage.

 **Note: Warranty service should be provided by an agent or repair organization approved by the manufacture.**

Note: this Manual is subject to any technical change without further notice. Please refer to the nameplate on the product for exact information.

